

## Data Sheet

### flowIQ® 3101

- 2 versions available:
  - Internal Radio (RF) or
  - Encoded Output (EO)
- Ultrasonic measurement
- Pinpoint accuracy
- 20 year longevity
- Dual temperature measurement
- IP68 Vacuum sealed construction
- Lead free stainless steel and zero lead brass certified to NSF/ANSI 61



## Contents

---

Technical data	4
Material	4
Meter sizes	5
Meter face details	6
Measurement of temperatures	6
Display and information codes	7
Data registers	8
Radio packet options	9
915MHz band RF – wireless radio communication	10
Encoded Output version	10
Encoded Output - ordering details	11
Encoded Output - wiring and pinouts	11
Encoded Output - visualization	12
Pressure loss	13
Ordering details	14
Configuration	15
Accessories	16

## Electronic ultrasonic cold water meter for measurement of cold water consumption in households, multi-unit buildings and industry.

---

### Pinpoint accuracy

Ultrasonic flow measurement guarantees pinpoint accuracy and longevity. Ultrasonic flow measurement is based on the transit time method, and all measurements, references, readings, calculations and data communication are controlled by an advanced, specially designed electronic circuit. Thus, the meter includes no moving parts, which makes flowIQ® 3101 resistant to wear and impurities in the water.

### Construction

The meter is hermetically closed and vacuum-sealed to prevent humidity from reaching the electronics and avoid condensation between the glass and display. The meter is IP68 (submersible) type tested and suitable for installation in meter pits.

### Installation

flowIQ® 3101 is easy to install in all operating environments, horizontally as well as vertically, independent of piping and installation conditions. Consumption data can be read visually from the display, using an optical eye, and remotely read, either by 915MHz band RF signal, built into the meter, or alternatively by a 3-wire encoded interface.

The Encoded Output meters will operate in Installation Mode immediately after water begins flowing through the meter. This reduces time and water consumption required to check that the meter is operational.

### Specific features

flowIQ® 3101 measures the water and environment temperatures and it includes leak detection, securing that water loss is discovered quickly.

The unique combination of all the flowIQ® 3101 features reduces current operating costs to measure water usage and minimizes unexpected expenses in connection with possible leakage.

### Environmentally friendly

The meter has been approved according to Drinking Water Standards in multiple countries, and it is certified to NSF/ANSI 61. The meter housing and measuring tube are made of the synthetic material polyphenylene sulfide (PPS), which is free from lead and other heavy metals. The environmental report, Carbon Footprint, documents the meter's high reusability and low environmental impact, including recycling of materials.

### Hygiene

To protect the health of the consumers Kamstrup has a hygienic manufacturing process of the water meters. Kamstrup has a highly automated manufacturing process, and only uses materials which are approved for drinking water. Furthermore the products gets disinfected before dispatch. The hygiene is being controlled by external accredited laboratories and by frequent audits.

### General description

flowIQ® 3101 is a hermetically closed static water meter, intended for the measurement of cold water consumption. The water meter uses the ultrasonic principle and has been designed and constructed on the basis of Kamstrup's experience in the development and production of static ultrasonic meters, since 1991.

flowIQ® 3101 has been subjected to a comprehensive set of tests to ensure a long-term, accurate and reliable meter. This technology has many advantages, including no moving parts so the meter is unaffected by particles in the water and measures consistently throughout its lifetime. Furthermore, the meter

has a start flow of only 0.04 GPM, which provides accurate measurement at low water flows.

The meter housing is made of plastic material polyphenylene sulfide (PPS) and is mounted on a measuring part made of stainless steel or zero lead brass. The meter can be installed vertically or horizontally and quickly mounted independent of existing piping and installation conditions.

The volume is measured using bidirectional ultrasonic technique based on the transit time method, proven as a long-term and accurate measuring principle. Two ultrasonic transducers send sound signals against and with the flow. The ultrasonic signal traveling with the flow reaches the opposite transducer first. The time difference between the two signals can be converted into flow velocity and thereby the volumetric flow rate can be calculated.

The accumulated water consumption is displayed by flowIQ® 3101 in gallons or cubic feet with nine digits and up to three decimals, to clearly display usage data. The display has been specially designed to obtain long lifetime and sharp contrast in a wide temperature range.

In addition to volume reading, a number of information codes are displayed.

The meter also measures both water and ambient temperature continuously, storing minimum, mean and maximum temperatures daily.

All registers are saved daily in the meter memory for 460 days. Monthly data for the latest 36 months are also saved.

The meter is fitted with an optical eye, which makes it possible to read consumption data and information codes, stored in the meter's data logger. Using a USB or Bluetooth connection, the optical eye gives access to configure the meter.

The water meter is powered by an internal lithium battery.

The meter can and must only be opened by one of Kamstrup's authorized service centers by means of special tools. If the meter has been opened and the seals have thus been broken, the meter is no longer valid for billing purposes. Furthermore, the factory guarantee no longer applies.

## Technical data

### Electrical data

Battery 3.65 VDC, 1 C cell lithium

### Mechanical data

Ambient temperature 35 °F...140 °F <sup>1)</sup>  
 Protection class IP68-rated (waterproof/submersible)  
 Fluid temperature 33 °F...120 °F  
 Storage temp. empty sensor -10 °F...140 °F <sup>1)</sup>  
 Maximum operating pressure Thread mounted: 300 PSI  
 Flange mounted: 300 PSI  
 3" version: 275 PSI

<sup>1)</sup>Note: Battery life is assured by limiting maximum temperature to 85 °F

### Accuracy

MPE (maximum permissible error) According to AWWA C-708

Meter approved for 33 °F...85 °F:

± 3 % in extended low flow range

± 1.5 % in 'normal flow' range

### Approvals

Certified to NSF/ANSI 61

Complies to part 15 of the FCC rules

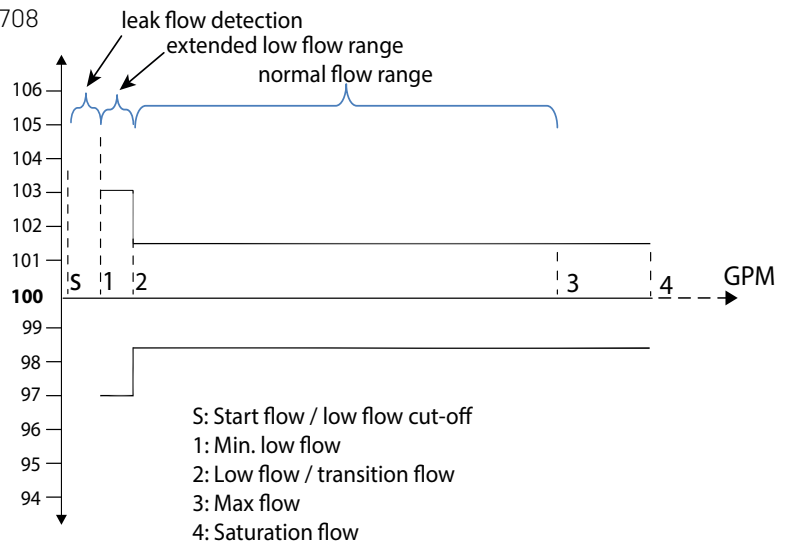

## Material

### Wetted parts

Meter housing Polyphenylene sulfide (PPS) with fiberglass reinforcement  
 Reflectors Stainless steel, 304L  
 Flow part, threaded/flanged Stainless steel, 316  
 Flow part, threaded Lead free brass

## Meter sizes

flowQ® 3101 is available in several sizes:

Type number (stainless steel)		Meter size	Max. flow for continuous operation	Start flow	Saturation flow rate	Min. flow	Transition flow	Pressure loss at max flow	Connection on meter NPSM thread/flange	Lay length
RF version	EO version									
			GPM (3)	GPM (S)	GPM	GPM (1)	GPM (2)	PSI	Inches	
03U-57-C02-8UX	03U-22-C02-8EX	1"	55	0.04	130	0.25	0.4	4.0	1¼" thread	10¾"
03U-57-C04-8UX	03U-22-C04-8EX	1½"	120	0.06	200	0.4	1.2	8.0	1½" thread	12¾"
03U-57-C06-8UX	03U-22-C06-8EX	1½"	120	0.06	200	0.4	1.2	8.0	1½" flange	13"
03U-57-C07-8UX	03U-22-C07-8EX	2"	160	0.1	330	0.5	1.5	2.0	2" thread	15¼"
03U-57-C08-8UX	03U-22-C08-8EX	2"	160	0.1	330	0.5	1.5	2.0	2" flange	17"
03U-57-C09-8UX	03U-22-C09-8EX	2"	160	0.1	330	0.5	1.5	2.0	2" flange	15¼"
03U-57-COM-8UX	03U-22-COM-8EX	3"	350	0.15	500	2.5	7.5	3.5	3" flange	12"

Type number (brass)		Meter size	Max. flow for continuous operation	Start flow	Saturation flow rate	Min. flow	Transition flow	Pressure loss at max flow	Connection on meter NPSM thread/flange	Lay length
RF version	EO version									
			GPM (3)	GPM (S)	GPM	GPM (1)	GPM (2)	PSI	Inches	
03U-57-C0A-8UX	03U-22-C0A-8EX	¾" (short)	35	0.015	50	0.10	0.15	5.3	¾" thread	7½"
03U-57-C0B-8UX	03U-22-C0B-8EX	¾" (long)	35	0.015	50	0.10	0.15	5.3	¾" thread	9"
03U-57-C03-8UX	03U-22-C03-8EX	1"	55	0.04	130	0.25	0.4	4.0	1¼" thread	10¾"

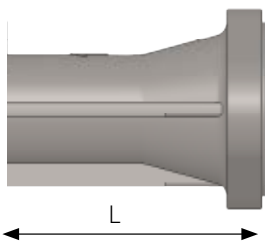

(for meter type 06, 08 and 09)

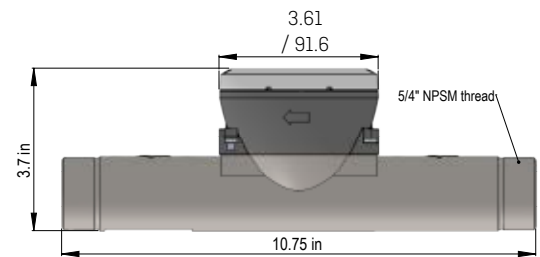
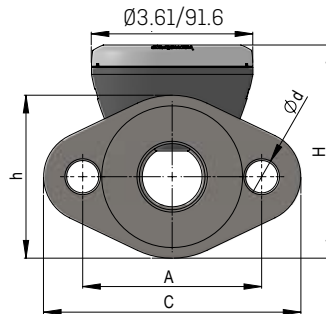

GPM	Connection	L	H	h	A	C	d	Weight approx. [Lbs]	Meter type
		Inches / (mm)	Inches / (mm)						
35	1" thread	7½"/190	3⅞/84	--	--	--	--	2.3	C0A
35	1" thread	9"/228	3⅞/84	--	--	--	--	2.5	C0B
55	1¼" thread	10¾"/273	3.7"/95	--	--	--	--	4.1	C02/C03
120	1½" thread	12¾"/321	3.9"/100	--	--	--	--	6.0	C04
120	1½" flange	13"/330	4.8"/122	3.6"/92	4.0"/102	5.7"/146	0.79"/20	13	C06
160	2" thread	15¼"/387	4.33"/110	--	--	--	--	9.2	C07
160	2" flange	17"/432	5.43"/138	4.13"/105	4.49"/114	6.54"/166	0.79"/20	19	C08
160	2" flange	15¼"/387	5.43"/138	4.13"/105	4.49"/114	6.54"/166	0.79"/20	17	C09
350	3" flange	12"/305	7.24"/184	--	4.24"/108	7.24"/184	0.75"/19	31	COM

## Meter face details

Meter information in permanent laser engraved text.

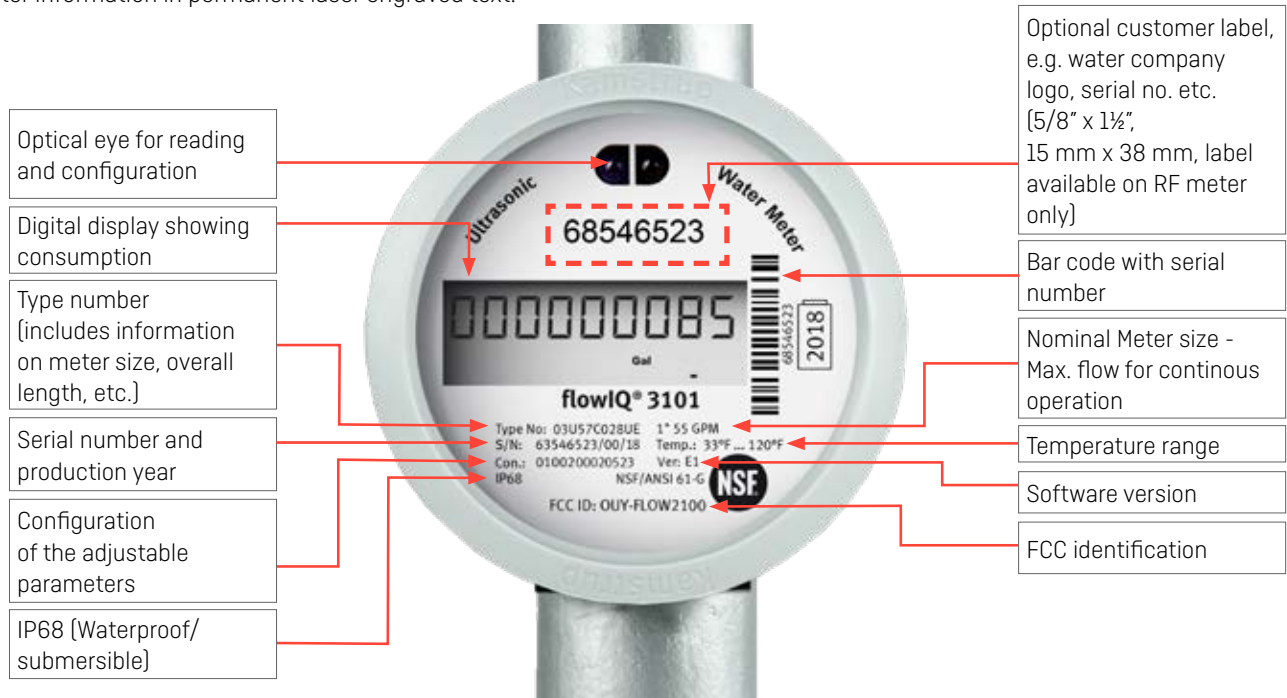

## Measurement of temperatures

### Temperature monitoring

flowIQ® 3101 measures ambient temperatures. The measurements can be used to monitor the installation and to give an indication of the temperature of the water when the water reaches the end user. Temperatures are logged in the daily and monthly records.

Minimum, mean and maximum values are logged daily. The register contains the last 460 days.

On the first day of each month the minimum, maximum and average temperatures, recorded in the past month, are stored in the register. The register stores values from the last 36 months.

Temperature values are referred to in °F and can be read via the optical eye and send by the Wireless RF radio signal. Optional temperature combinations in the radio package are described in the section 'Optional data in data logger'.

### Ambient temperatures

Monitoring the ambient temperature of the installation can be used as a warning of freezing temperatures or unintended high temperatures. The measurement in the meter housing corresponds to the ambient temperature where the meter is installed. The temperature is measured every minute. The maximum and minimum values are calculated based on a 2 minute average value. The average temperature is a time-weighted mean value.

## Display and information codes

flowIQ® 3101 can be read from the large, easily readable, specially designed display. Nine large figures indicate number of gallons or cubic feet. The last three figures may indicate decimals.

The information codes in the display have the following meaning and function:



Info code flashes in the display	Meaning
FLOW	The FLOW infocode is the digital equivalent of a spinning proving wheel featured on many mechanical meters. Indicates water flow through the meter. If there is no flow, the text will be off. This text does not blink.
LEAK	The water has not been stagnant in the meter during the last few days. This can be a sign of a leaky tap or toilet.
BURST	The water flow has exceeded a preprogrammed limit for a minimum of 30 minutes which is a sign of a burst pipe.
TAMPER	Attempt of fraud. The meter is no longer valid for billing.
Gal / ft³ / m³	Consumption is indicated in gallons, cubic feet or cubic meters
VERIFIC	Will always be off when the meter is in operation - text will be on during factory control and verification of the meter.
DRY	The meter is not water-filled. In this case nothing will be measured.
REVERSE	The water flows through the meter in the wrong direction.
RADIO OFF <sup>1)</sup>	The meter is still in transport mode with the built-in radio transmitter turned off. The transmitter turns on automatically when the first quarter gallon of water has run through the meter.
Squared 'dot'	One small square flashing indicates that the meter is active.
A' followed by a number Change log	Indicates the number of metrologic changes the meter has gone through after factory verification. If no adjustments have been made both the A symbol and the digit are inactive. When the meter is toggled to visualize Encoded Output, the letter A and the following digit have different meanings: A = Encoded Output changed from factory configuration, E = Encoded Output visualization mode

Information codes 'LEAK', 'BURST', 'DRY' and 'REVERSE' switch off automatically, when the conditions that activated them no longer exist. In other words, 'LEAK' disappears when the water is stagnant; 'BURST' disappears when the consumption falls to normal level; 'REVERSE' disappears when the water no longer flows in the wrong direction; and 'DRY' disappears when the meter again is filled with water.

Note: 1) RADIO OFF will not display on Encoded Output meters.

## Data registers

---

flowIQ® 3101 has an integrated data logger, in which the values of various data logs are saved.

The meter includes the following registers:

Data logging interval	Data log records	Logged value
Monthly logger	36 months	See table below
Daily logger	460 days	See table below
Info logger	50 events	Info code, meter reading and date

Therefore, it is always possible to read target volume and information codes for each of the latest 36 months as well as corresponding meter reading and possible information codes for each of the latest 460 days. The data logs can only be read via the meter's optical eye.

The monthly log is written on the first day of the subsequent month; the daily logger is written at midnight.

The following registers are logged:

Register type	Description	Monthly logger, 36 months	Daily logger, 460 days
Date [YY.MM.DD]	Logging time, year, month and day	•	•
Volume	Current meter reading (legal)	•	•
Operating hour counter	Accumulated number of operating hours	•	•
Info	Information code	•	•
Vol Reverse	Volume during reverse flow	•	–
Date of max. flow	Date stamp of max. flow during period	•	–
Max. flow, V1	Value of max. flow during period	•	•
Date of min. flow, V1	Date stamp of min. flow during period	•	–
Min. flow V1	Value of min. flow during period	•	•
Min. temp.	Meter temperature – minimum	•	•
Max. temp.	Meter temperature – maximum	•	•
Medium temp.	Meter temp. – time weighted average	•	•

Every time the information code changes, date and information codes are logged. Thus, it is possible to read the latest 50 changes of the information code as well as the date the change was made. Reading is only possible via the optical eye.



## Radio packet options

### Optional RF output

flowIQ® 3101 communicates via a high-power antenna and integrated 915MHz band RF, which gives access to easy and fast wireless reading of the meter.

The integrated 915MHz band RF transmits a data package every 16 seconds. In order to obtain long battery lifetime, the data package has been compressed and includes only the most important meter readings. The radio is ready for multi-channel transmission to avoid interference with nearby transmitters.

Besides readout of the current total registered water use, the meter saves a number of other consumption data.

Following values can be send via the Wireless RF radio signal:

- Target Volume - e.g., meter read from the first day of the month
- Maximum flow - daily
- Maximum flow - monthly
- Selected values of ambient temperature.

### Optional registers in data logger

It is possible to select one data package; content is illustrated below. The choices are determined by means of the selected R-value when ordering a water meter, as shown to the right in the figure.

In addition the RF package will contain actions and historical events from the infologger from within the past 30 days.

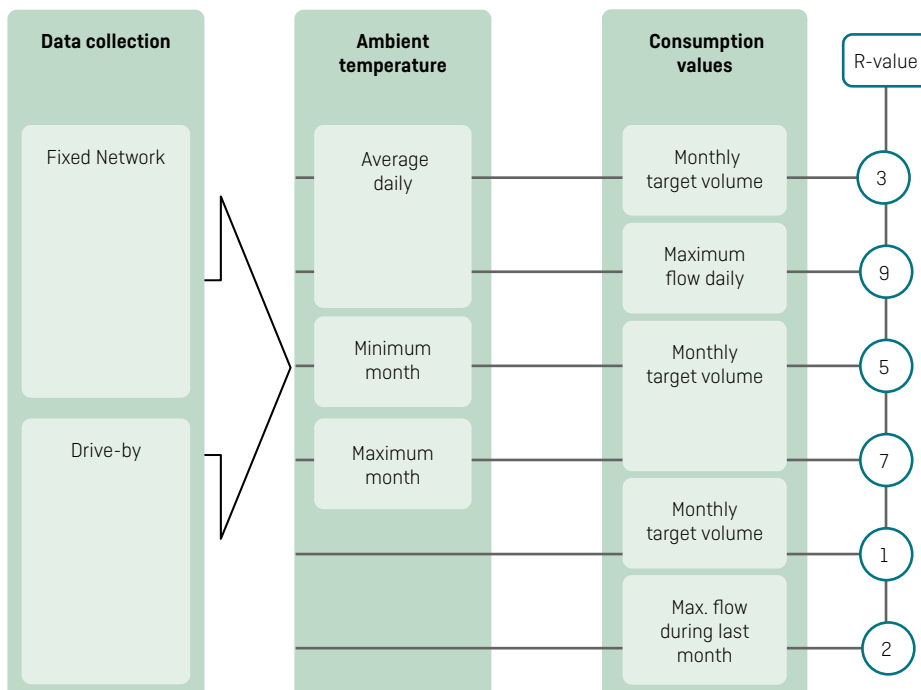

## 915MHz band RF – wireless radio communication

---

### Standardized and open communication

915MHz band RF is an open standard, following EN13757-4 : 2010, which means that while the flowIQ® 3101 can be configured with or without encryption of the transmitted signal, encryption is required in the United States.

Encryption protects personal data against unauthorized monitoring. Furthermore, the encryption file provides easy access to import meter data for reading programs.

### State of the art meter reader

Kamstrup offers mobile meter reading via either the USB meter reader for wireless platforms or READy for use via android based smart phones and tablets.

## Encoded Output version

---

### General description

Encoded Output is compatible with a number of RF network systems. In addition to Type Number and Configuration Code, three additional items are required to specify Encoded Output version meters:

EO Order Code: Letters A through Z, which specifies Data Packet and EO Digits  
Alarms included: Default = ON, optional = OFF \*)

### Connector/Cable Type:

Itron or Nicor – with cable length 5' 15' and 25' and  
Open end solid strain cables – also of 3 lengths: 5', 15' and 25'

All must be ordered separately as accessories.

### Encoded Output packages

18 Encoded Output options are available, which transmit from 4 to 9 digits, via the following three protocols:

Sensus UI-1203	4 to 9 digits, with or without extended alarms, 16 total EO options
Neptune E-Coder	8 digits, with Neptune alarms, 1 EO option

\*) Note. Kamstrup Alarm Protocol [KAP] is available and included by default with all Sensus data protocols; Neptune E-Coder includes [Neptune] alarms; Neptune ProRead does not support alarms.

## Encoded Output - ordering details

### Encoded Output ordering details - total of 18 ordering options

Encoded Output Description	EO Digits Visualization	Order Code
Sensus 9-digit	[987654321]	Z
Sensus 8-digit	[98765432*]	A
Sensus 7-digit	[9876543**]	B
Sensus 7-digit [-1]	[*8765432*]	C
Sensus 6-digit	[987654***]	D
Sensus 6-digit [-1]	[*876543**]	E
Sensus 6-digit [-2]	[**765432*]	F
Sensus 5-digit	[98765****]	G
Sensus 5-digit [-1]	[*87654***]	H
Sensus 5-digit [-2]	[**76543**]	J
Sensus 5-digit [-3]	[***65432*]	K
Sensus 4-digit	[9876*****]	L
Sensus 4-digit [-1]	[*8765****]	M
Sensus 4-digit [-2]	[**7654***]	N
Sensus 4-digit [-3]	[***6543**]	P
Sensus 4-digit [-4]	[****5432*]	Q
Neptune 8-digit [E-Coder]	[98765432*]	X
Neptune 6-digit [ProRead]	[987654***]	Y

## Encoded Output - wiring and pinouts

### Connector pinouts

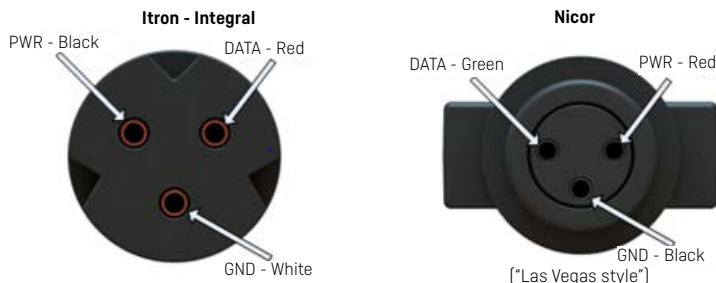

### Wiring cross reference

Function	Kamstrup	Sensus	Neptune	Itron Integral	Itron Remote
DATA	Green	Green	Red	Red	Brown
PWR/Clock	Red	Red	Black	Black	Yellow
GND	Black	Black	Green	White	Grey

## Encoded Output - visualization

### Visualization of Encoded Output configuration

Under normal operation, the 9-digit LCD will show the contents of the Volume V1 data register. Using a magnet, the Encoded Output Configuration can be briefly visualized, after which the LCD automatically reverts to display V1 Volume. The figures to the right show normal display mode [visualization not activated].

To indicate that additional alarms are included, the small "dot" is enabled.

Sample Register for  $\frac{1}{8}$ " meter used in examples, typical configuration for residential meters. The figures to the right show the Encoded Output Configuration [visualization activated].

#### Example 1 - Option D, Sensus 6-digit, Extended Alarms: OFF

EO Resolution. Meters configured in:

USG - 6 most significant digits; 10s of US Gallons

CuFt - 6 most significant digits; whole Cubic Feet

Order Option D, Sensus 6-digit, without Extended Alarms, factory EO configuration

#### Example 2 - Option Z, Sensus 9-digit, Extended Alarms: ON

EO Resolution. Meters configured in:

USG - 7 most significant integer digits + tenths and hundredths of US Gallons

CuFt - 6 most significant integer digits + tenths and hundredths and thousandths of Cubic Feet

#### Example 3 - Neptune 8-digit (E-Coder):

EO Resolution. Meters configured in:

USG - 7 most significant integer digits + tenths of US Gallons

CuFt - 6 most significant integer digits + tenths and hundredths of Cubic Feet

Note: Neptune 8-digit (E-Coder) data package can be distinguished by the display of LEAK and BURST alarms. Sensus 8-digit data package contains all or none of the Alarms [see figure by example 2].

Gallons



Cubic feet

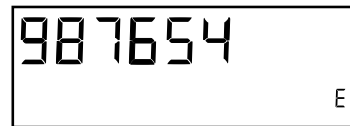
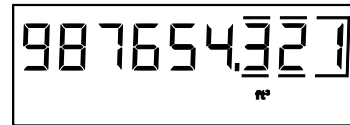

## Pressure loss

The following graph shows pressure loss with respect to flow rate, and according to AWWA standards the flow rate at 15 psi is emphasized:

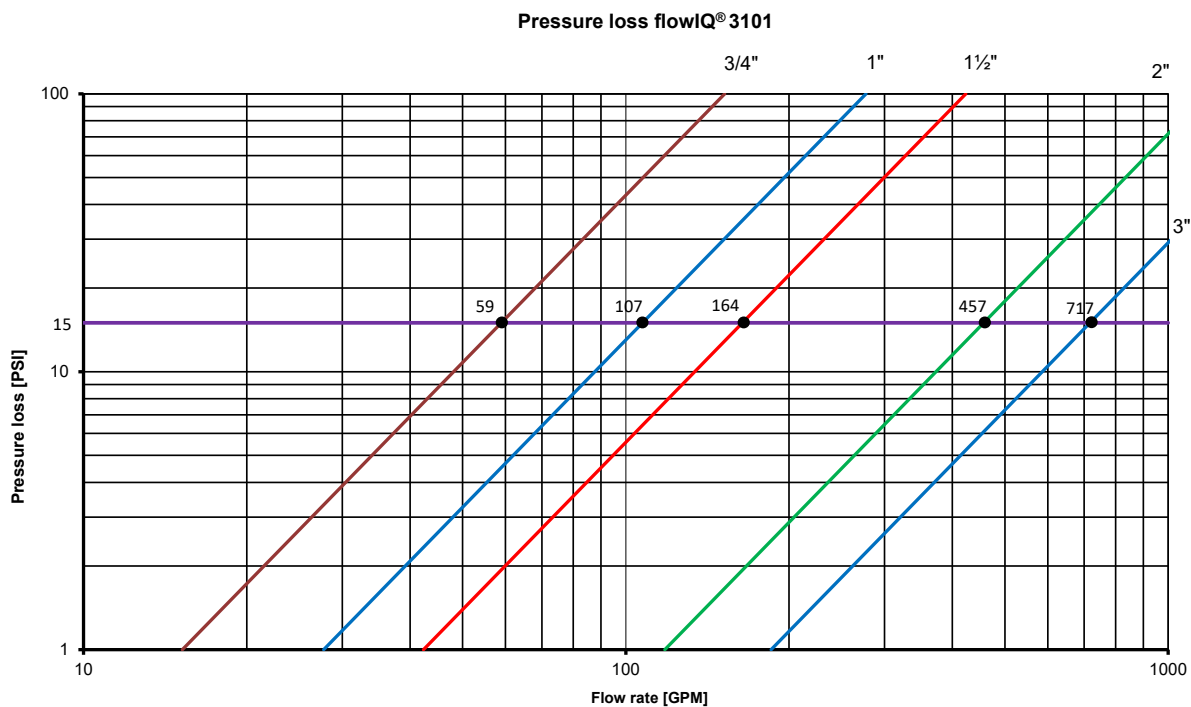

## Ordering details

Start your order by stating the type number of the selected model of flowIQ® 3101. The type number includes information on meter type - meter version (Radio or Encoded Output), size, lay length, service connection and time zone.

The features included in the Type Number cannot be changed once the meter has been produced.

Subsequently the meter configuration, which determines customer-specific requirements such as number of digits in display etc., is selected. The configuration is completed during programming of the final meter.

Refer to Encoded Output Specification for further ordering details, for the Encoded Output version meter.

Fiber gaskets are included with all flowIQ® 3101 meters. The enclosed fiber gaskets must be used in order to achieve max operating pressure.

Accessories are enclosed separately to be mounted by the installer.

### Type number

<b>flowIQ® 3101</b>	<b>Type 03U</b>	<input type="checkbox"/>	<input type="checkbox"/>	<b>C</b>	<input type="checkbox"/>	<input type="checkbox"/>	<b>8</b>	<input type="checkbox"/>	<input type="checkbox"/>
<b>Communication</b>									
RF, 3 channel, narrow band – 915 MHz US							57		
Encoded output 4- to 9-digit – Extended Alarms							22		
<b>Battery</b>									
									C
<b>Meter size</b>									
<b>GPM</b>	<b>Connection</b>	<b>Length [inches/mm]</b>							
35	¾"/1" thread	7½"/190							0A
35	¾"/1" thread	9"/228							0B
55	1"/1¼" thread	10¾"/273							02
55	1"/1¼" thread	10¾"/273							03
120	1½"/1½" thread	12¾"/321							04
120	1½"/1½" flange	13"/330							06
160	2"/2" thread	15¾"/387							07
160	2"/2" flange	17"/432							08
160	2"/2" flange	15¾"/387							09
350	3" flange	12"/305							0M
<b>Cold water meter</b>									
									8
<b>Meter type</b>									
Radio									U
Encoded output									E
<b>Time zone</b>									
Eastern									E
Central									C
Mountain									M
Pacific									P

# Configuration

	KK	LLL	MMM	N	P	R	S	T
<b>Target date for RF package</b> <sup>[2]</sup>								
01 <sup>st</sup> of the month <sup>[1]</sup>	01							
10 <sup>th</sup> of the month	10							
15 <sup>th</sup> of the month	15							
<b>Average time of max. values</b> - 2 minutes		002						
<b>Customer label code</b> (available for RF meters only)			MMM					
<b>Leakage message limit</b>								
Continuous GPH for 24 hours - for meter size:	<b>¾"</b>	<b>1"</b>	<b>1½"</b>	<b>2"</b>	<b>3"</b>			
OFF	--	--	--	--	--	0		
Flow continuously > 0.5 % of max. flow	10	17	36	48	105	1		
Flow continuously > 1.0 % of max. flow	21	33	72	96	210	2		
Flow continuously > 2.0 % of max. flow	42	66	144	192	420	3		
Flow continuously > 0.25 % of max. flow	5	8	18	24	52	4		
Flow continuously > 0.1 % of max. flow	2	3	7	10	21	5		
<b>Pipe burst limit</b>								
Total gallons within 30 minutes - for meter size:	<b>¾"</b>	<b>1"</b>	<b>1½"</b>	<b>2"</b>	<b>3"</b>			
OFF	--	--	--	--	--	0		
Flow > 5 % of max. flow for 30 minutes	52	83	180	240	525	1		
Flow > 10 % of max. flow for 30 minutes	105	165	360	480	1050	2		
Flow > 20 % of max. flow for 30 minutes	210	330	720	960	2100	3		
<b>Optional data in RF package</b> <sup>[2]</sup>								
Monthly target volume							1	
Maximum flow (monthly)							2	
Monthly target volume / Time weighted average temp. meter - daily							3	
Monthly target volume / Min. temp. meter - latest month							5	
Monthly target volume / Max. temp. meter - latest month							7	
Daily max. flow / Time weighted average temp. meter - daily							9	
<b>Display resolution</b>								
000000.001 m <sup>3</sup>								0
000000001 Gal								1
00000000.1 Gal [Default setting for US Gallon configured meters - 1½" and 2"]								2
0000000.01 Gal								3
000000.001 Gal								4
000000001 ft <sup>3</sup>								5
00000000.1 ft <sup>3</sup>								6
0000000.01 ft <sup>3</sup> [Default setting for cubic feet configured meters - 1½" and 2"]								7
000000.001 ft <sup>3</sup>								8
<b>Encryption level for RF package</b> <sup>[2]</sup>								
Encryption with separately forwarded key								3
<b>Unless otherwise stated in the order, Kamstrup supplies the following:</b>	<b>01</b>	<b>002</b>	<b>000</b>	<b>2</b>	<b>0</b>	<b>5</b>	<b>2</b>	<b>3</b>

Note: [1] Monthly target date KK is 01 by default, but can be configured for 10 and 15, which also affects the day of the month for monthly log calculations. [2] Configuration Codes KK, R and T affect only the RF version meter. Default values are used for E0 meters, but serve no purpose.

## Accessories

---

See Accessories for Water Meters: [58101743\\_US](#).

For information about our Hygiene concept go to: [products.kamstrup.com](http://products.kamstrup.com).